

1

2

3

4

A



B

C

D

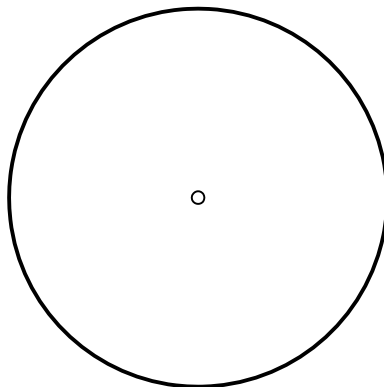
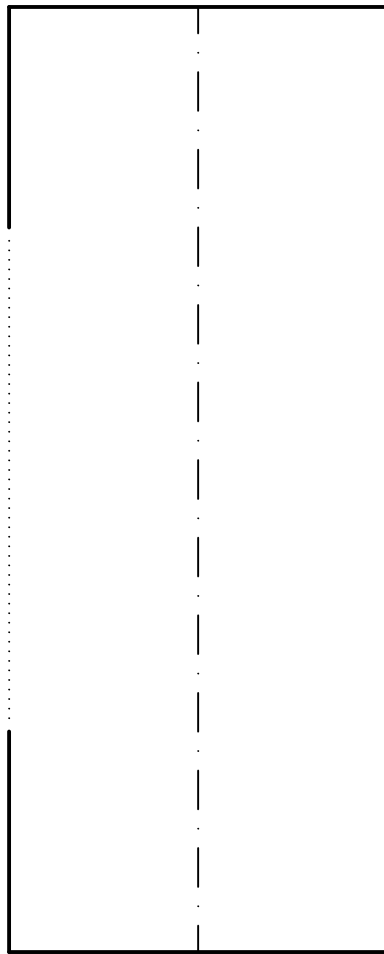
E

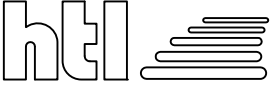

Dokumentenart	Masse	Genehmigt von	Halbzeug - Werkstoff	
Gesetzl. Eigentümer	Erstelldatum	Erstellt durch	Klasse	Beurteilung
www.htl.at/kop1	Format A4	Maßstab	Sachnummer	
F  bildung mit zukunft	Blatt/Blätter 1/6	Titel, Zusätzlicher Titel Rohrverbindung		Toleranzen DIN ISO 2768-mK
				

1

2

3

4

A

B

C

D

E

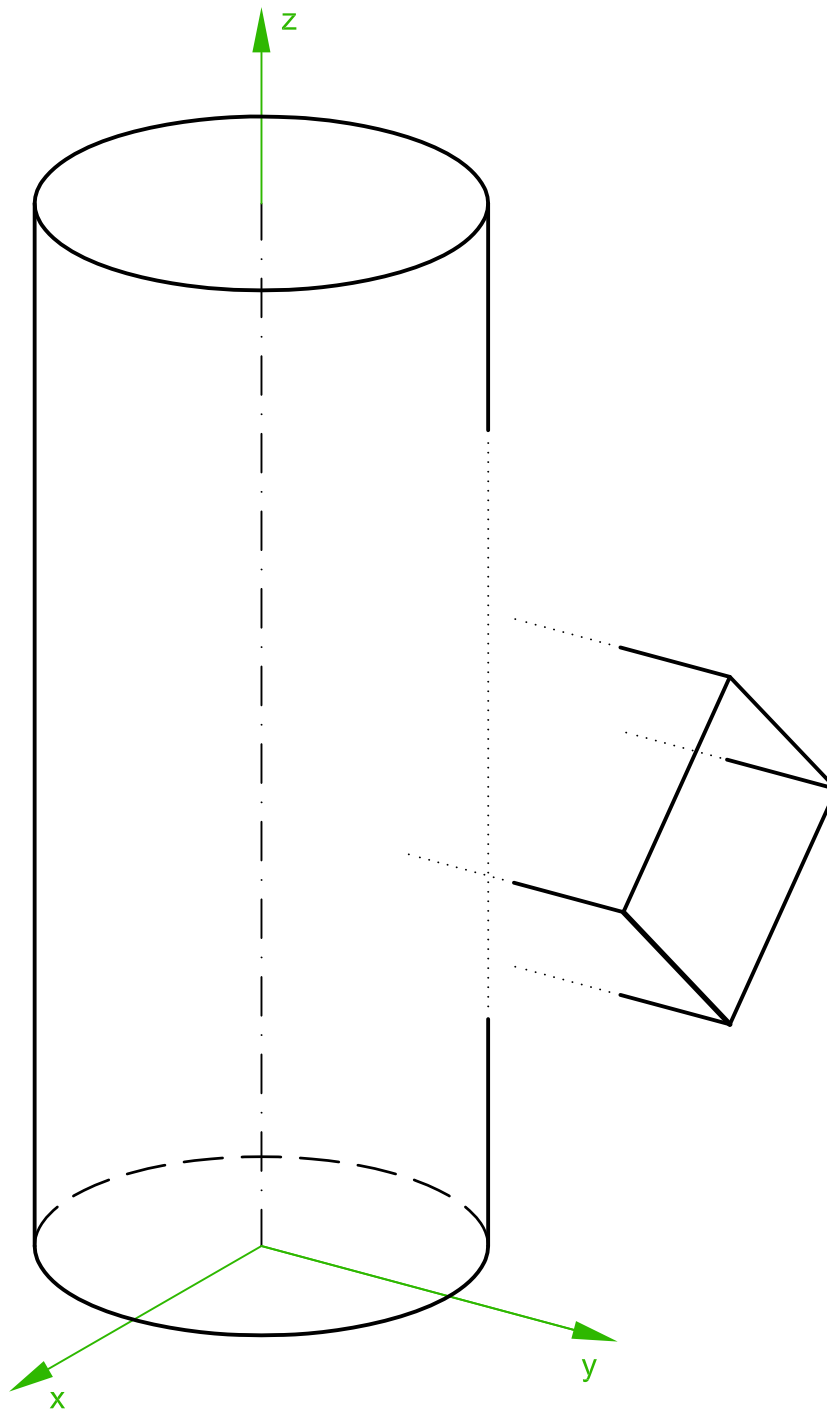

Dokumentenart	Masse	Genehmigt von	Halbzeug - Werkstoff	
Gesetzl. Eigentümer	Erstelldatum	Erstellt durch	Klasse	Beurteilung
www.htl.at/kop1	Format A4	Maßstab	Sachnummer	
F  bildung mit zukunft	Blatt/Blätter 2/6	Titel, Zusätzlicher Titel Rohrverbindung		Toleranzen DIN ISO 2768-mK
				

1

2

3

4

A



B

C

D

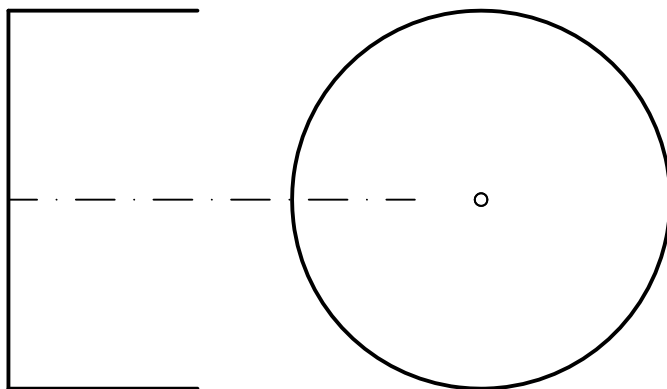
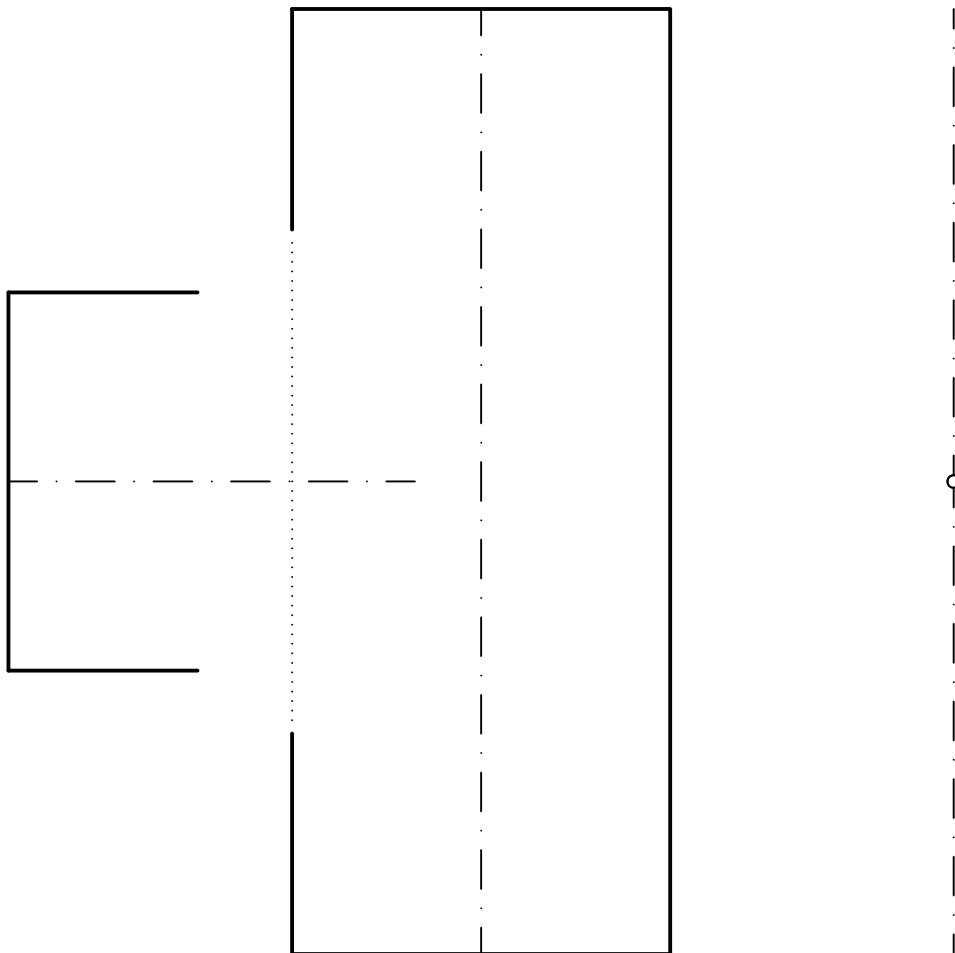
E



Dokumentenart	Masse	Genehmigt von	Halbzeug - Werkstoff	
Gesetzl. Eigentümer	Erstelldatum	Erstellt durch	Klasse	Beurteilung
www.htl.at/kop1	Format A4	Maßstab	Sachnummer	
F  bildung mit zukunft	Blatt/Blätter 3/6	Titel, Zusätzlicher Titel Rohrverbindung		Toleranzen DIN ISO 2768-mK
				

1

2

3

4

A



B

C

D

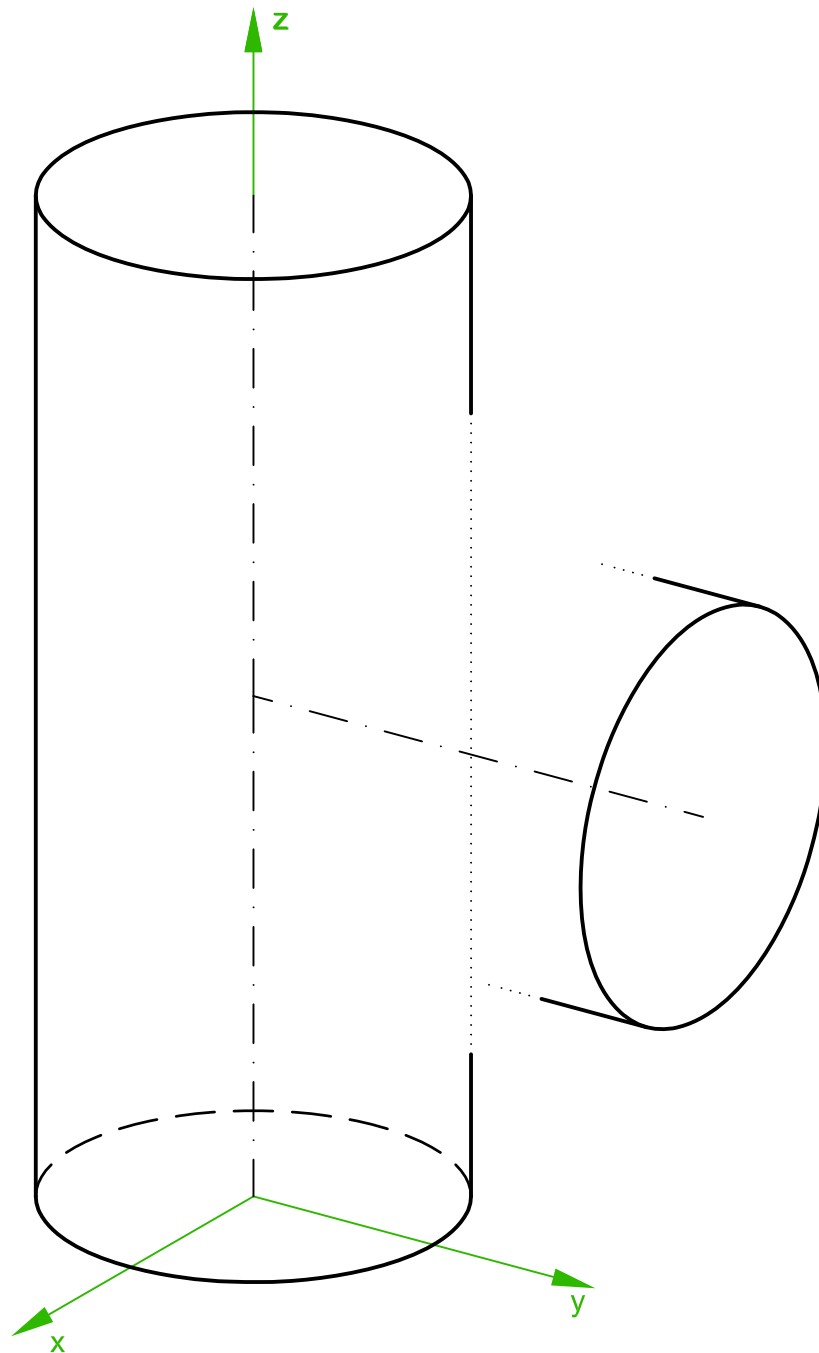
E



Dokumentenart	Masse	Genehmigt von	Halbzeug - Werkstoff	
Gesetzl. Eigentümer	Erstelldatum	Erstellt durch	Klasse	Beurteilung
www.htl.at/kop1	Format A4	Maßstab	Sachnummer	
F  bildung mit zukunft	Blatt/Blätter 4/6	Titel, Zusätzlicher Titel Rohrverbindung		Toleranzen DIN ISO 2768-mK
				

1

2

3

4

A

B

C

D

E

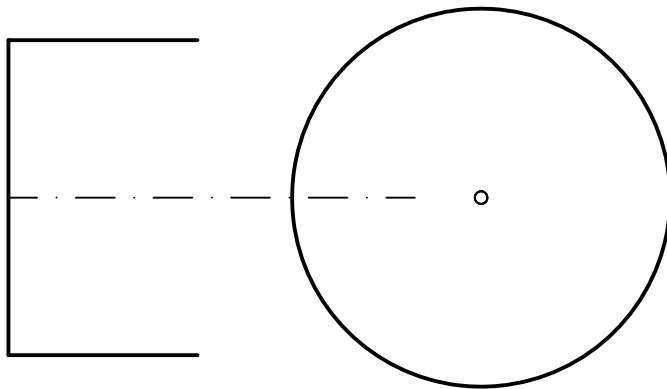
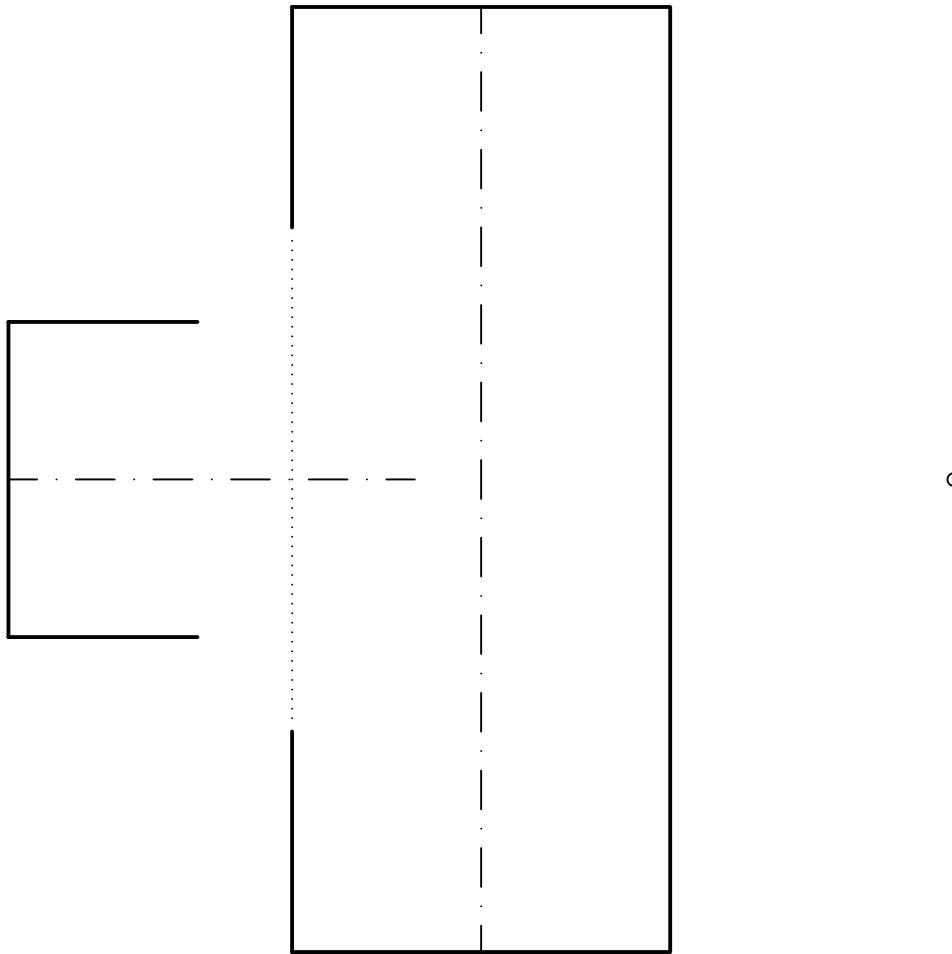

Dokumentenart

Masse

Genehmigt von

Halbzeug - Werkstoff

Gesetzl. Eigentümer

Erstelldatum

Erstellt durch

Klasse

Beurteilung

www.htl.at/kop1

Format

Maßstab

Sachnummer

A4

Blatt/Blätter

Titel, Zusätzlicher Titel

Toleranzen

5/6

Rohrverbindung

DIN ISO 2768-mK

htl
bildung mit zukunft



1

2

3

4

A

B

C

D

E

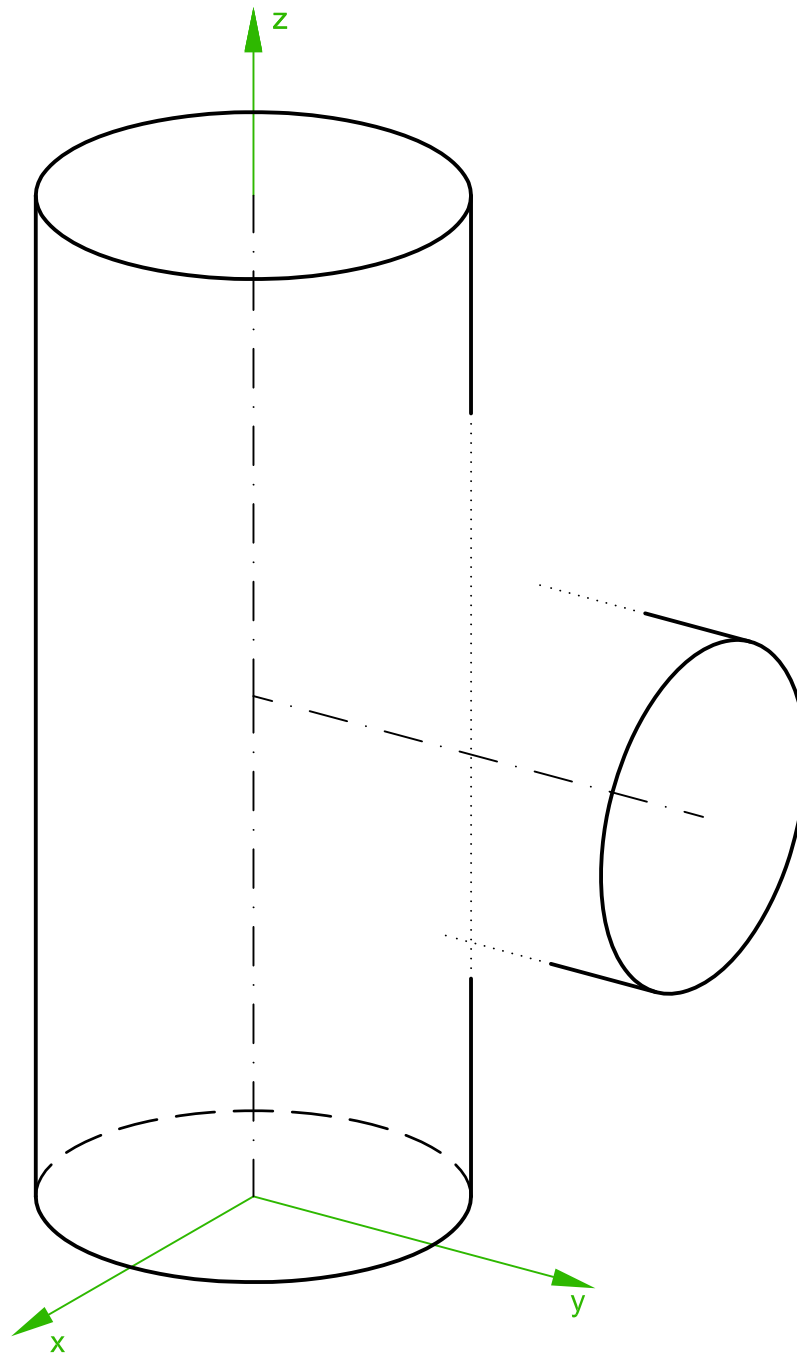

Dokumentenart	Masse	Genehmigt von	Halbzeug - Werkstoff	
Gesetzl. Eigentümer	Erstelldatum	Erstellt durch	Klasse	Beurteilung
www.htl.at/kop1	Format A4	Maßstab	Sachnummer	
F  bildung mit zukunft	Blatt/Blätter 6/6	Titel, Zusätzlicher Titel Rohrverbindung		Toleranzen DIN ISO 2768-mK
	